

550 Torch Handle & Attachments

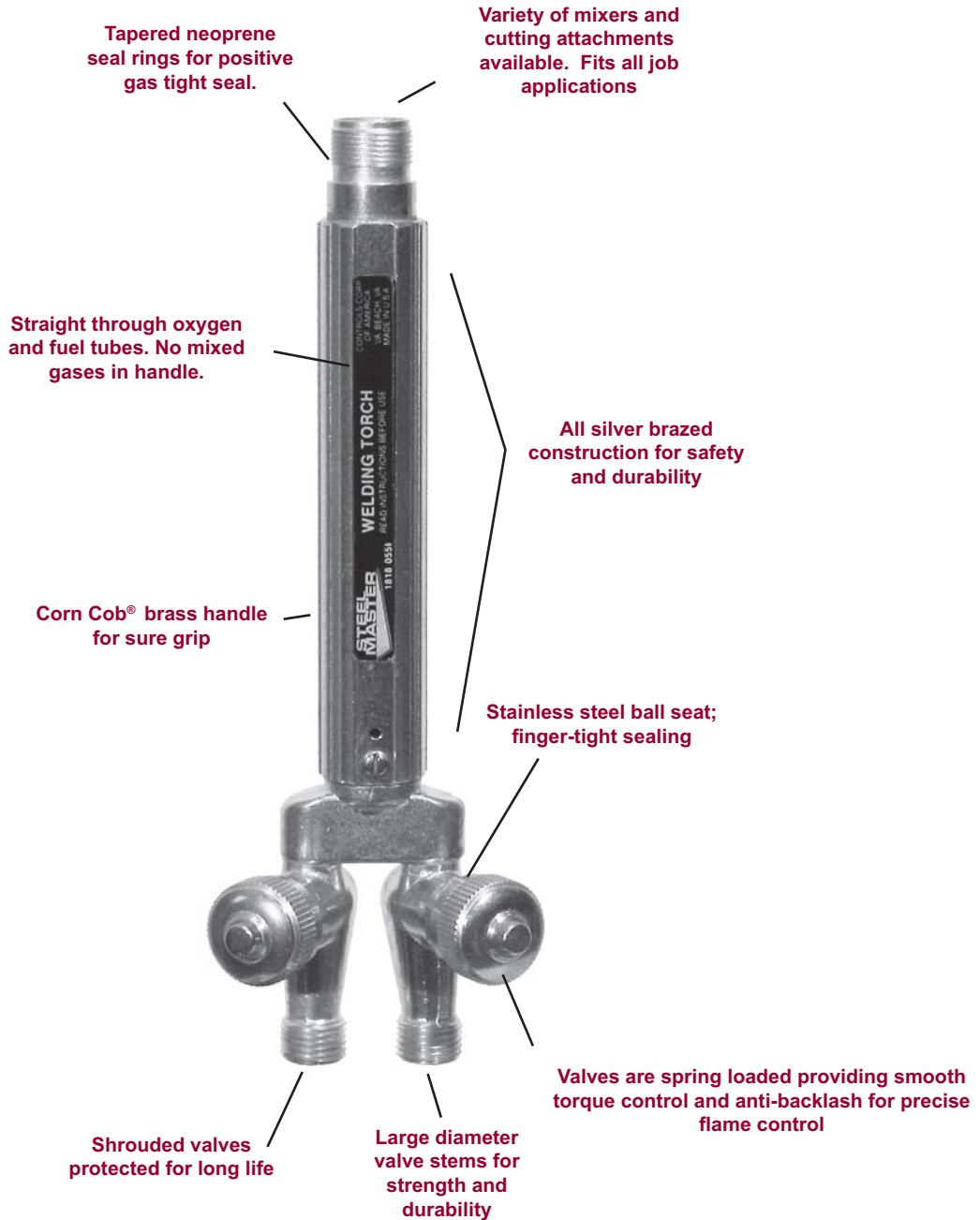

Cutting Handles



Style 761
Replacement Heads
Size 5 to 10

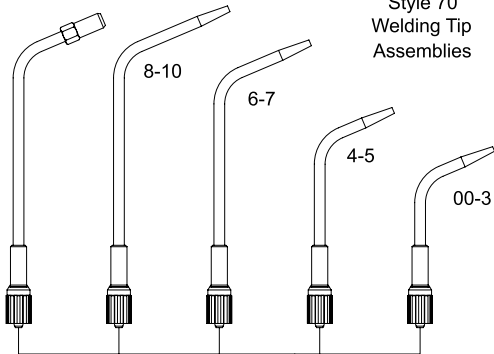

Style 70
Welding Tip
Assemblies

Style 760
Universal
Heating Tip
Assemblies
Size 5 to 10

Style 550 Torch

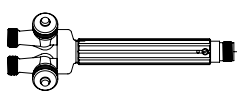

Style 3590
Cutting Attachment

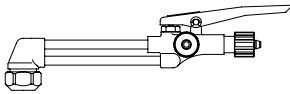

All 3/4" 3 Land
Cutting Tips
For All Fuels

Mixer
810 0781
Size 1 to 10
(3/8-20F)

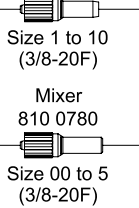

Mixer
810 0780
Size 00 to 5
(3/8-20F)

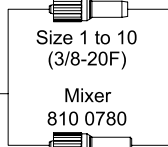

811 0414

Extensions
(3/8-20m
x
1/4-32m)

810 5701

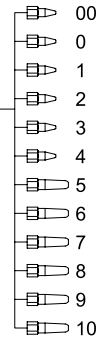

Style 9
Welding
Tips
Sizes
00-10
(1/4-32F)

811 1411

Extensions
(3/8-20m
x
5/16-24m)

810 0829

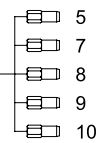

Style 759
Multi-Flame
Heating Tips
Sizes
5-10
(5/16-24F)

811 1412

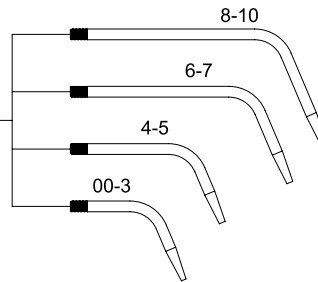

Style 98
Separable Tip
Sizes
00-10
(3/8-20m)

Attachments
& Handles